

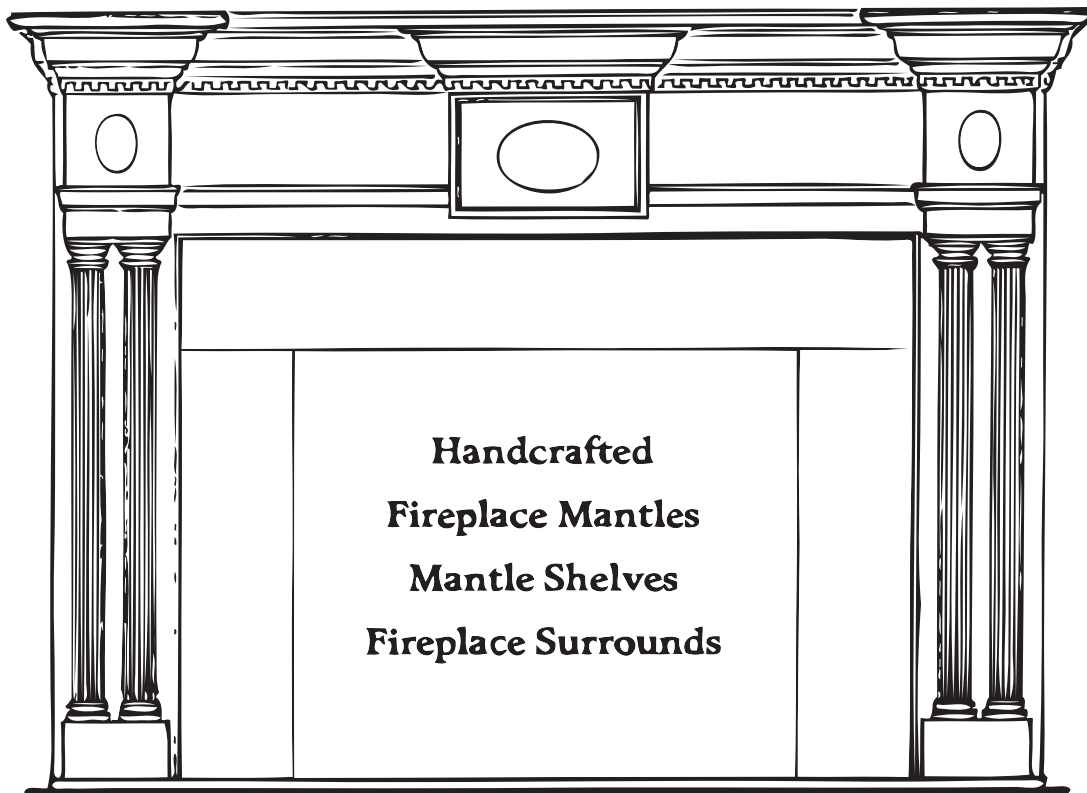

Cumberland

Trim Doors & Design

"STRIVING TO BE THE BEST IN INTERIOR MILLWORK."



3025 Hwy. 90
Bronston, Kentucky 42518
Phone (606) 561-4242
Fax (606) 561-4379
www.cumberlandtdd.com

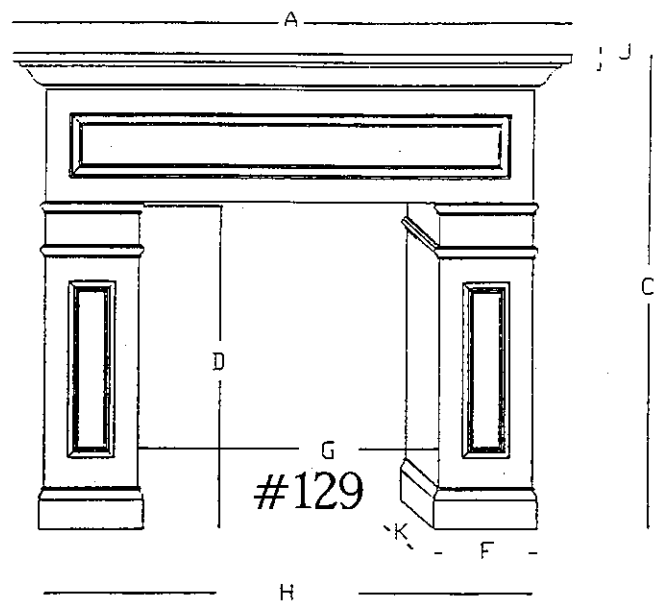
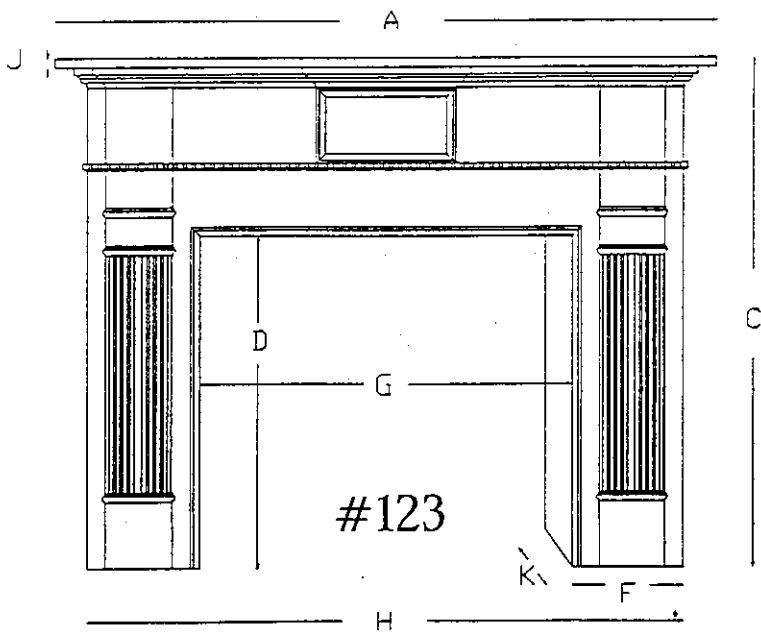
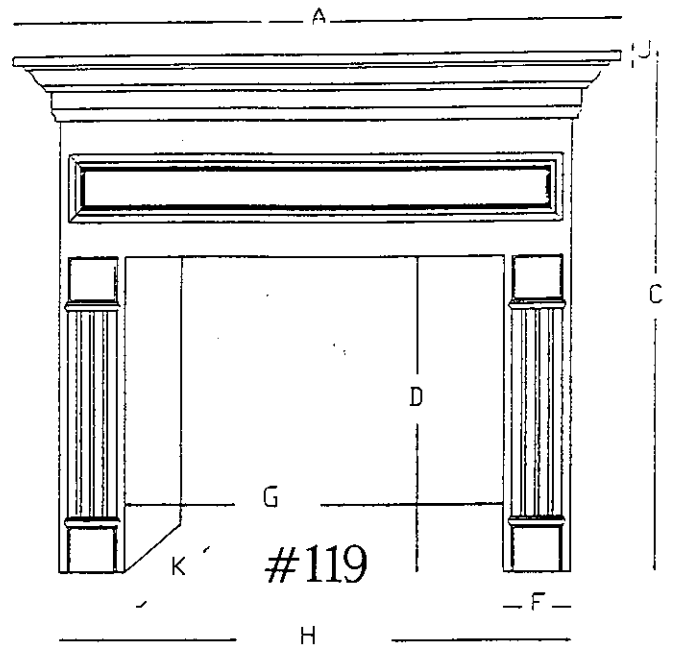
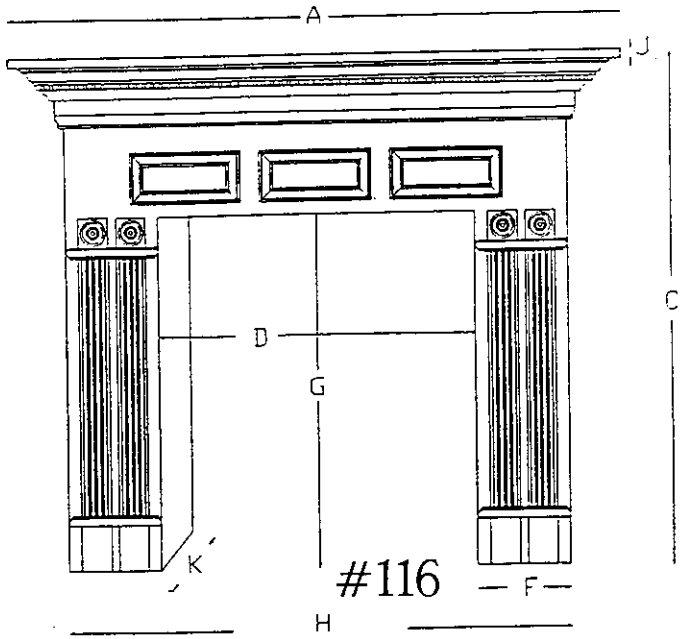
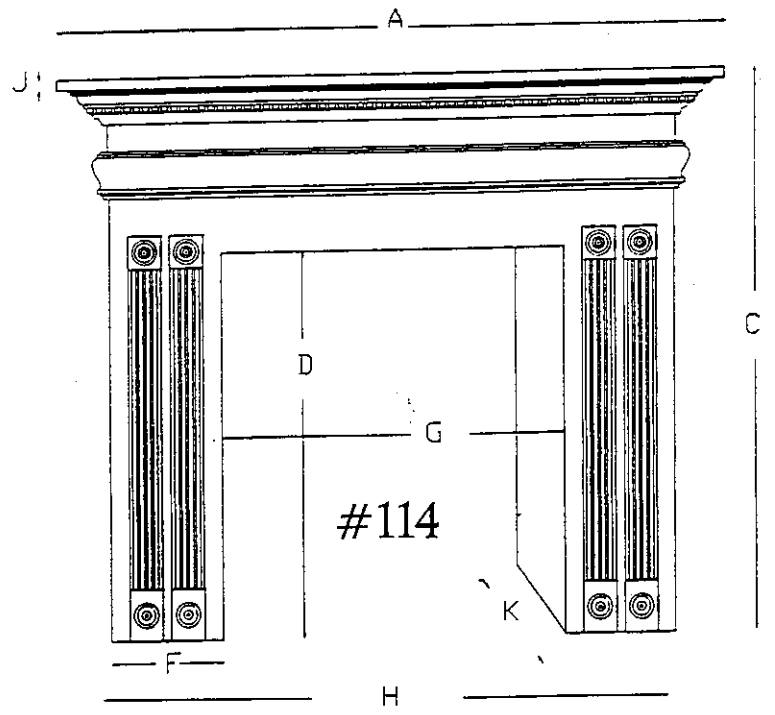
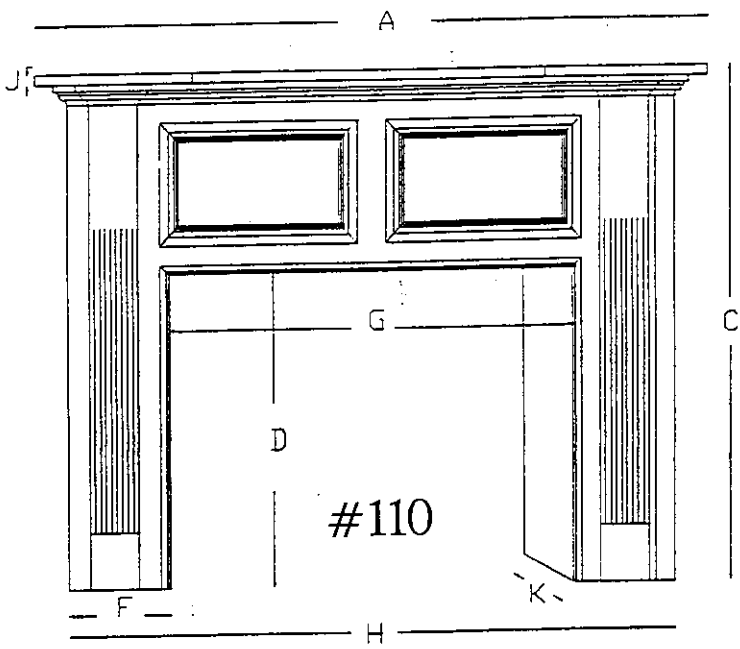

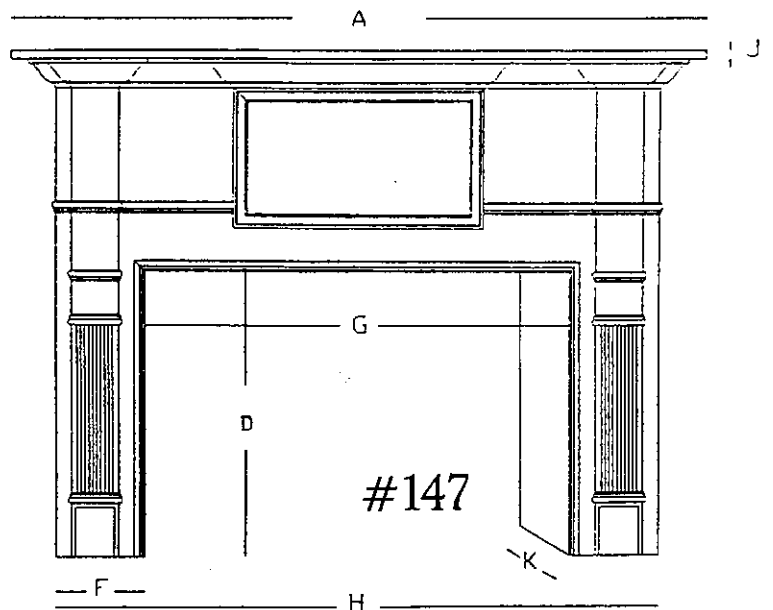
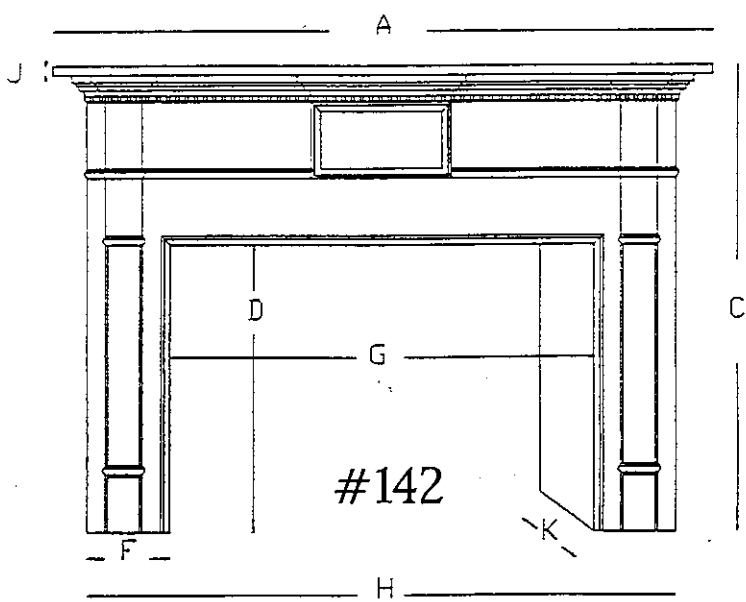
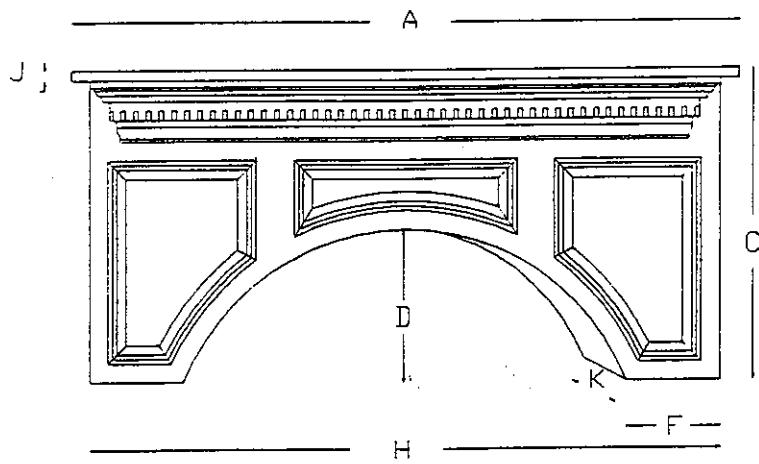
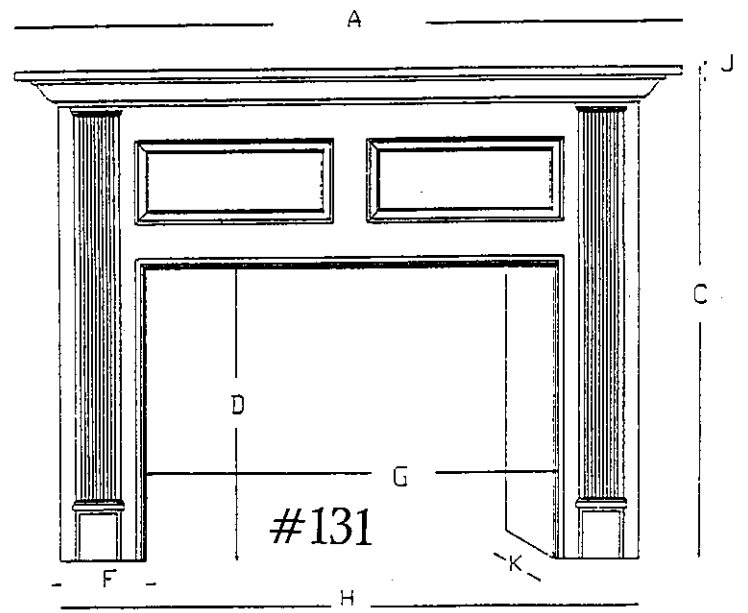
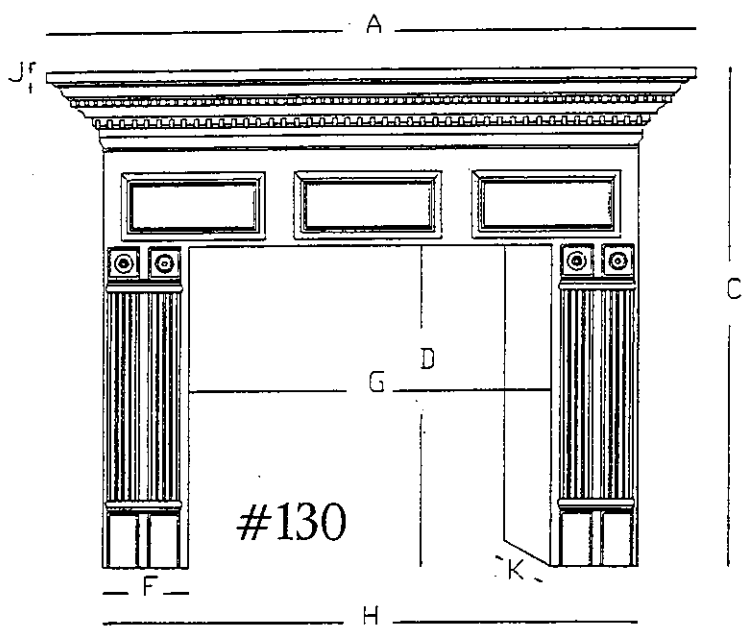

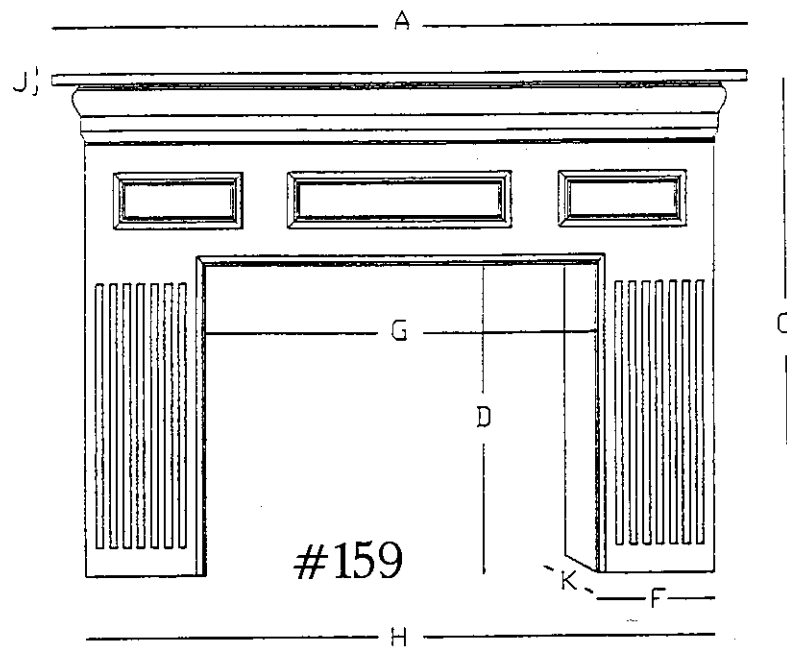
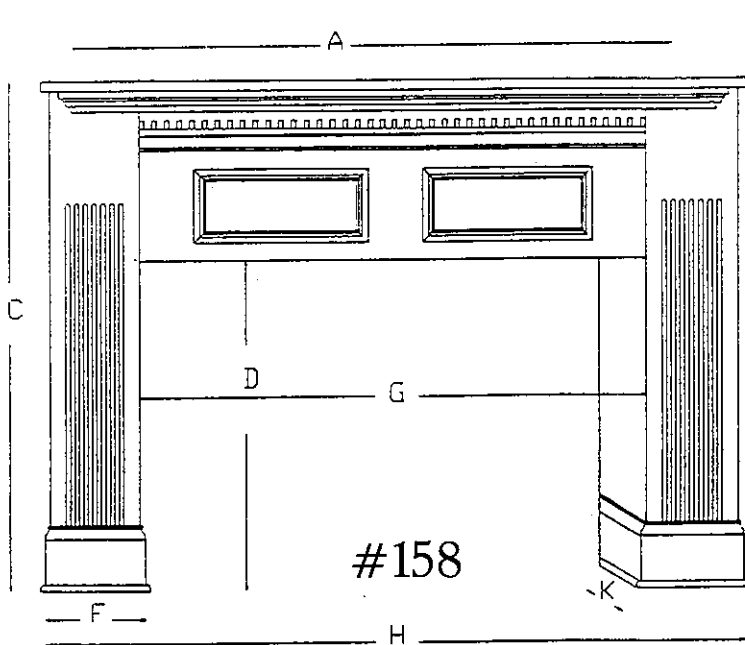
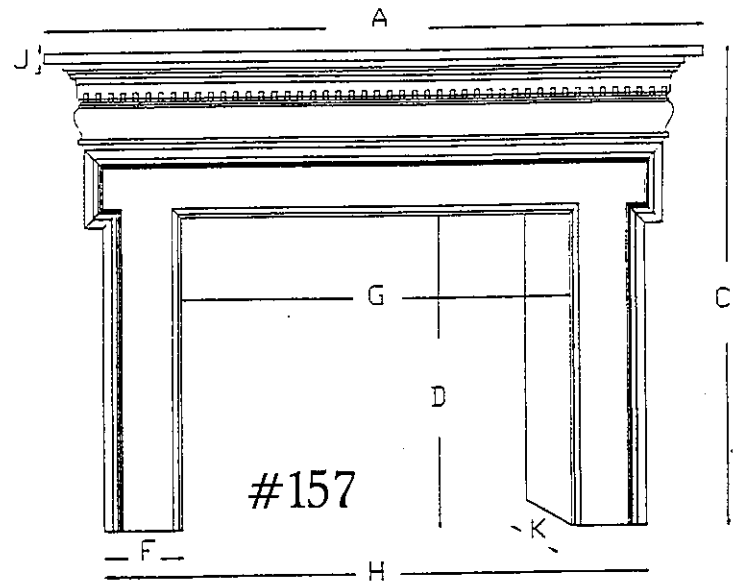
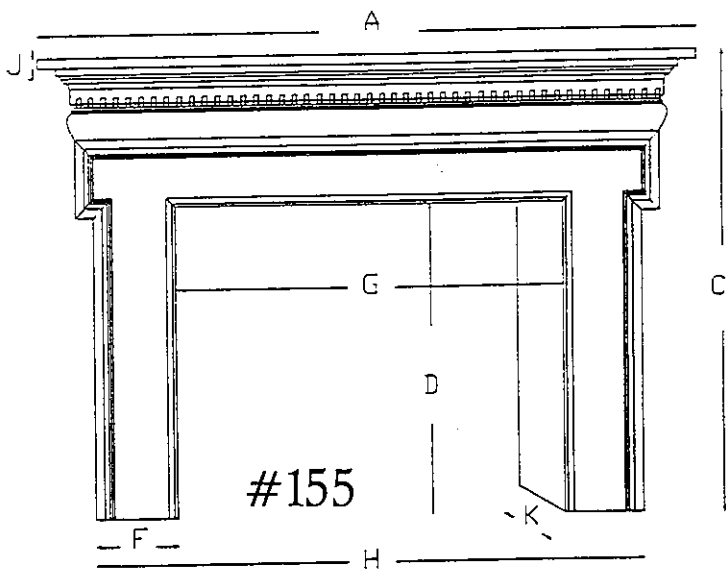
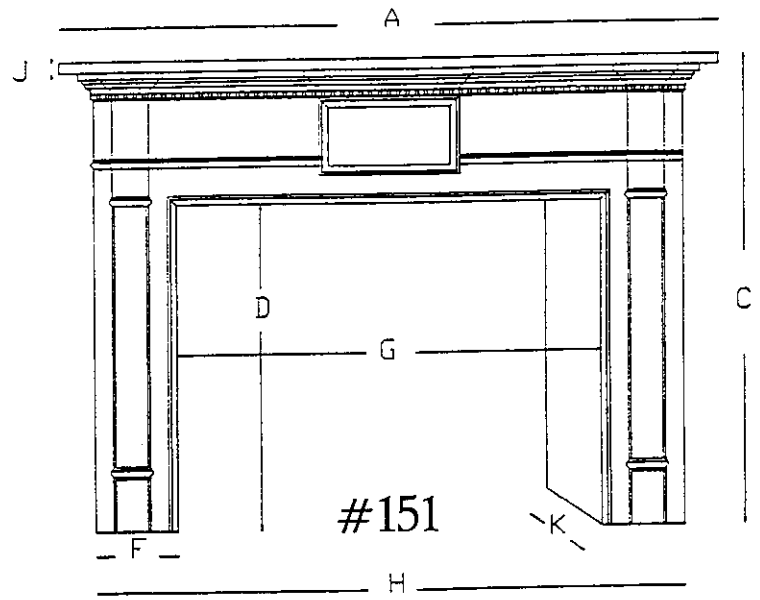
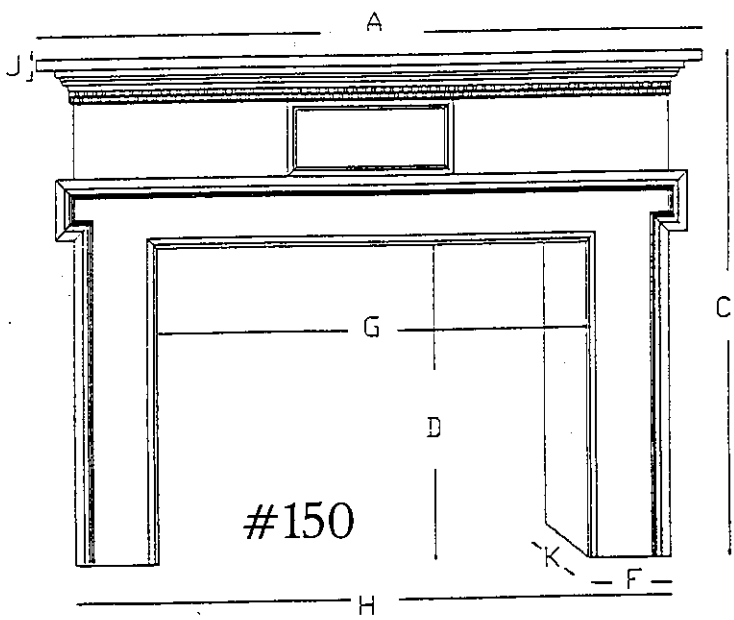

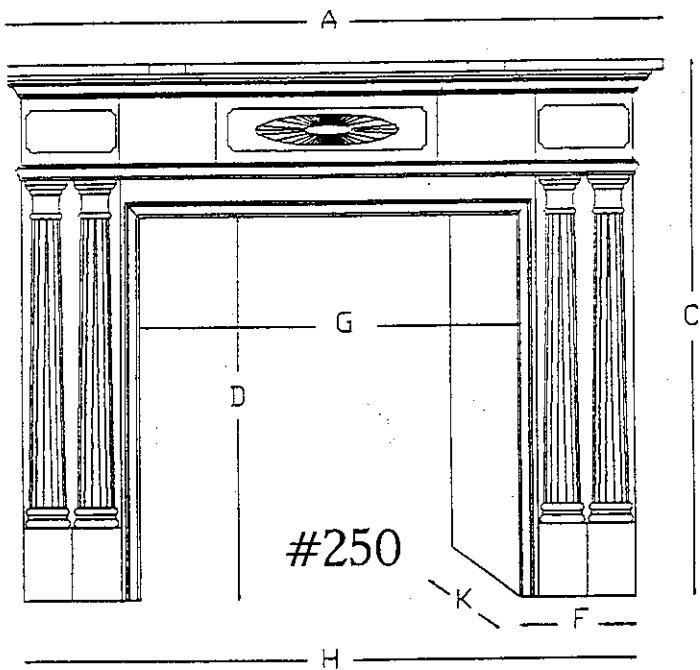
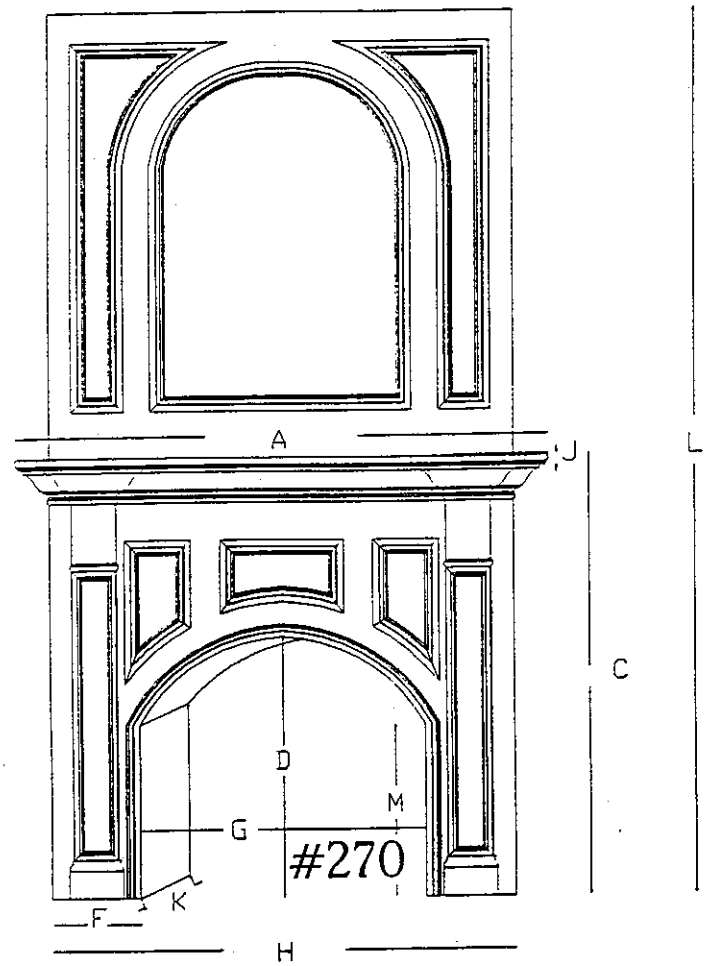
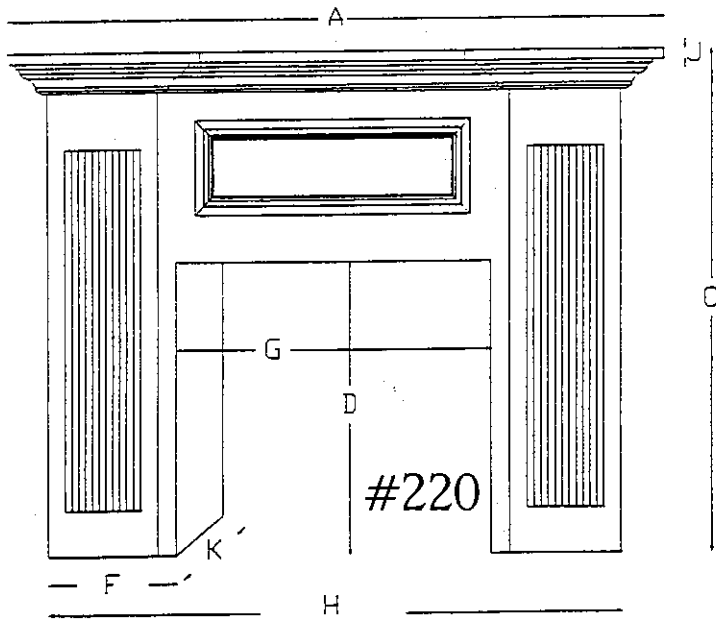
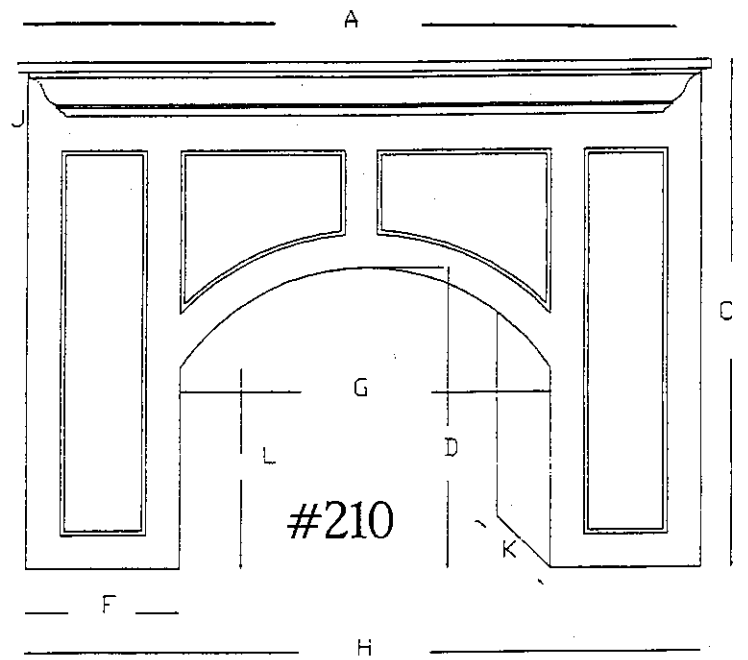
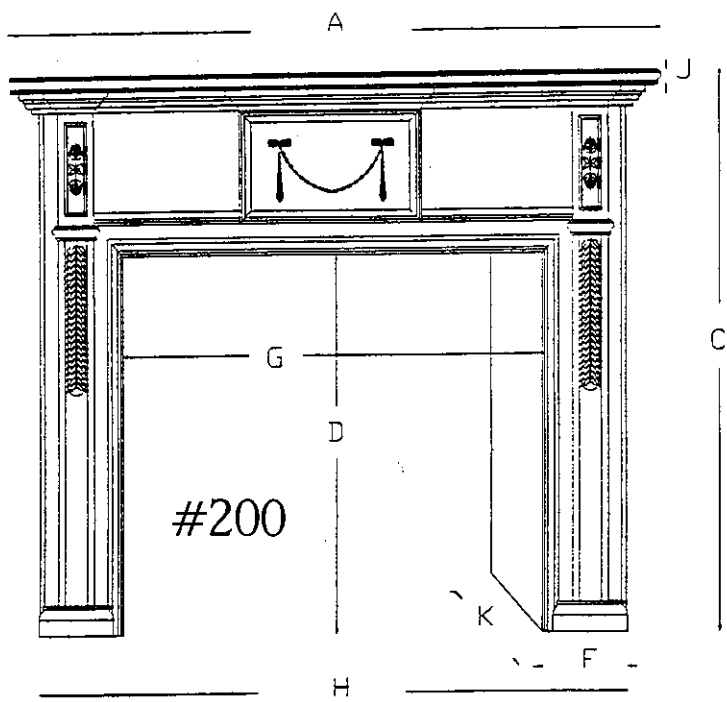

ORDER

Cumberland Millwork & Supply

Date _____

Salesman _____

3025 Hwy. 90 • Bronston, Kentucky 42518
Phone (606) 561-4242 • Fax (606) 561-4379

Invoice To _____

Ship To _____

Phone # _____

Order Taken By _____

Name of Person Ordering _____

Date Received _____

Customer P.O. # _____

Date Promised _____

Date on P.O. # _____

Date Shipped _____

Mantel Style _____

Species _____

Paint (P) or Stain (S) _____

*Please refer to your purchase guide
before filling in the blanks below.

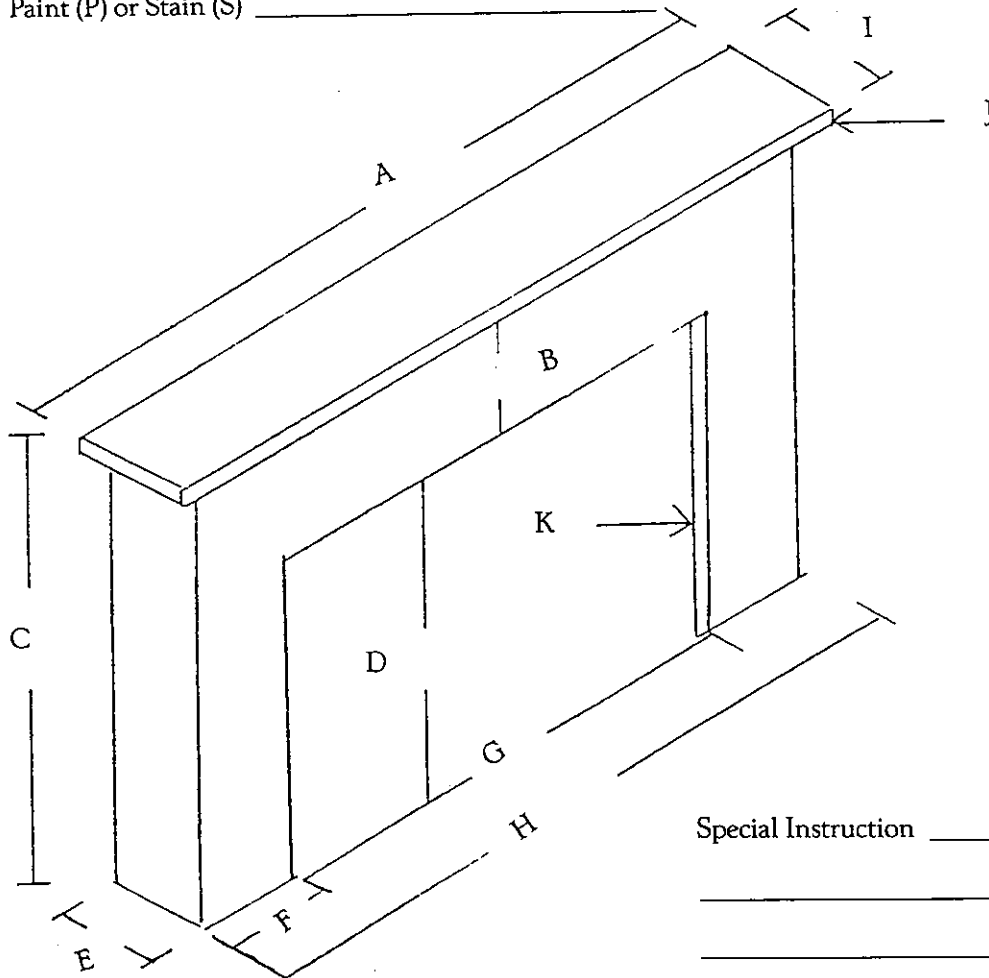

- _____ A Shelf Length
- _____ B Breast Height
- _____ C Overall Height
- _____ D Inside Height
- _____ E Outside Projection
- _____ F Leg Width
- _____ G Inside Width
- _____ H Overall Width
- _____ I Shelf Width
- _____ J Shelf Thickness
- _____ K Inside Projection

Special Instruction _____

